



Ceramic Resonator

SMD-version
KX-ZTT CP series

Built-in capacitor types

part no.	12.99826
model	KX-ZTT-CP MG
frequency	4.090 MHz
internal capacitance C ₁ , C ₂	22 pF
frequency tolerance at +25°C	±0.5%
frequency stability at -20° ~ +80°C	±0.3%
aging for 1 year max.	±0.1%
resonant resistance max.	30 Ohm
test circuit IC	1/6 IC 4069 UBPX2
contents of reel	4000 pcs.

* Please note for Ceramic Resonators our „Precaution for Handling“.

Dimensions (mm):

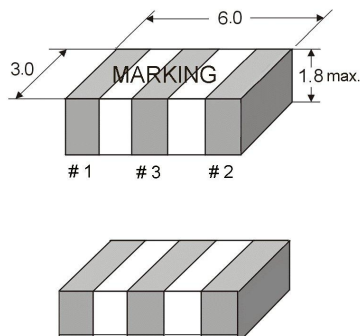

Reflow soldering condition:

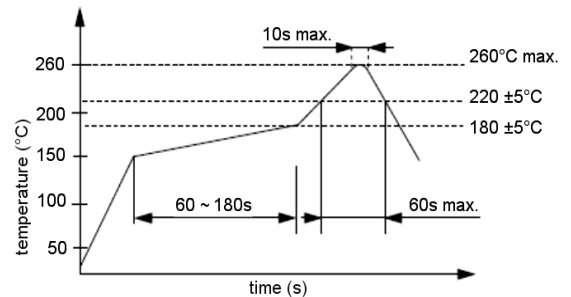

Test circuit:

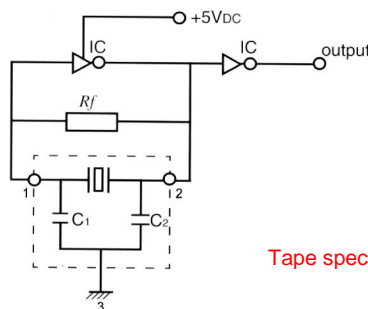

Suggested soldering pad:

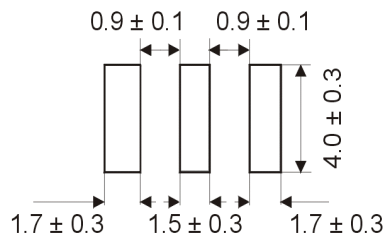

Tape specification:

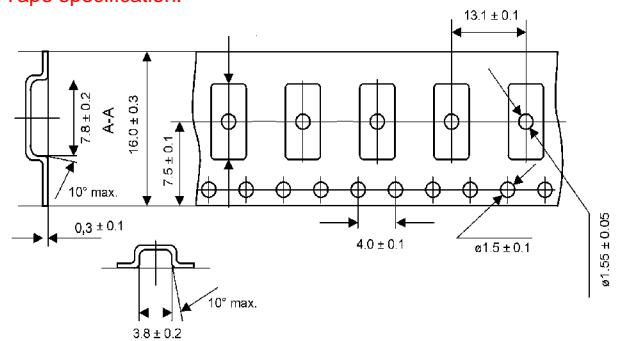

reel diameter 330 mm