



Clock Oscillator SMD-version

+3.3V

part no.	12.94371
model	KXO-V97
frequency	7.37280 MHz
frequency stability at -20° ~ +70°C	±50 ppm
operating temperature	-20° ~ +70°C
storage temperature	-55° ~ +125°C
symmetry	50% ±10% at ½ V _{DD} level
rise & fall time max.	6 ns
"0" level max.	+0.4V
"1" level min.	V _{DD} -0.5V
input voltage V _{DD}	+3.3V ±10%
input current	4.0 mA typ., 6.0 mA max.
output load	30 pF
start up time max.	10 ms
tristate function	yes
disable delay time max.	50 µs
enable delay time max.	4 ms
phase jitter	(12 kHz – 20 MHz) with 1 ps
random jitter max.	7ps
peak to peak jitter max.	40ps
contents of reel	1000 pcs.

Dimensions (mm):

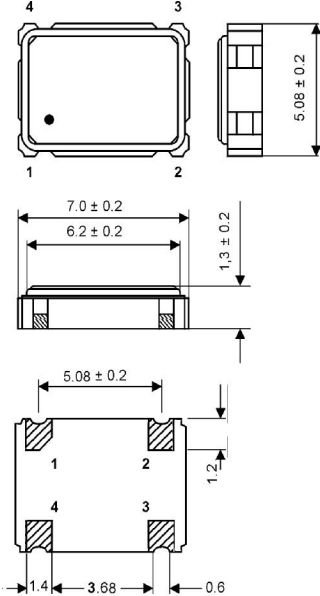

Output waveform:

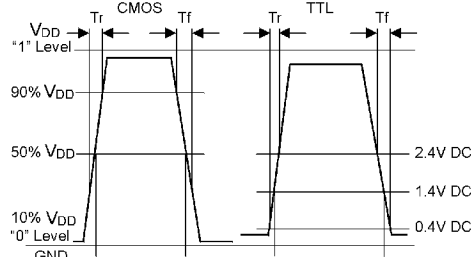

Reflow soldering condition:

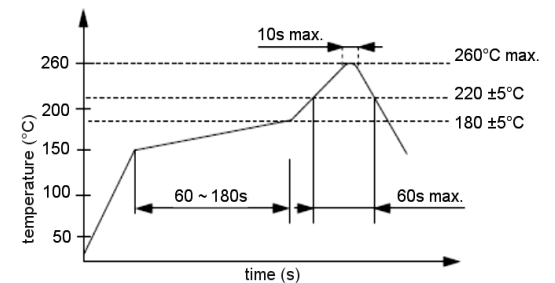

Test circuit:

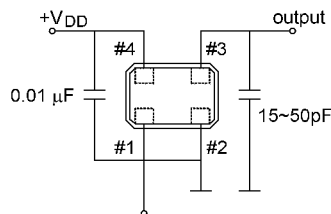

Tape specifications:

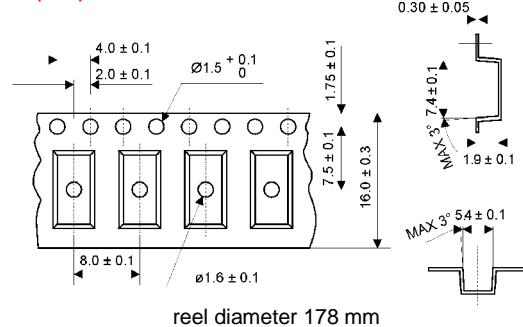

Suggested soldering pad:

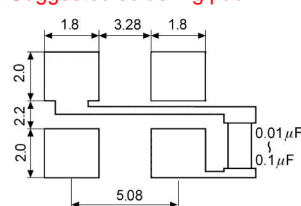

PIN	Connection
1	"L" (0V) "H" or OPEN
2	GND
3	Z OUTPUT
4	V _{DD}

Z: high impedance