



Clock Oscillator

SMD-version

5V

part no.	12.94229
model	KXO-97
frequency	64.0 MHz
frequency stability at -20° ~ +70°C	±50 ppm
operating temperature	-20° ~ +70°C
storage temperature	-55° ~ +125°C
symmetry	50% ±10% at 1.4V DC level or ½ V _{DD} level
rise & fall time max.	5 ns
"O" level max.	+0.4V (TTL) +0.5V (CMOS)
"1" level min.	+2.4 (TTL) V _{DD} -0.5V (CMOS)
input voltage V _{DD}	+5V DC ±10%
Input current	40 mA typ., 50 mA max.
output load	5 TTL gates 30 pF
start up time max.	10 ms
tristate function	yes
disable delay time max.	50 µs
enable delay time max.	4 ms
phase jitter	(12 kHz – 20 MHz) with 1 ps
random jitter max.	7ps
peak to peak jitter max.	40ps
contents of reel	1000 pcs.

Dimensions (mm):

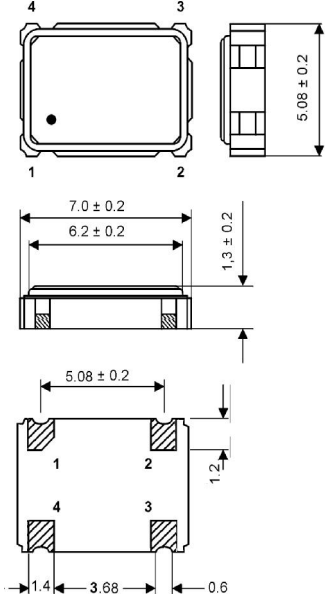

PIN	Connection
1	"L" (0V) "H" or OPEN
2	GND
3	Z OUTPUT
4	V _{DD}

Z: high impedance

Output waveform:

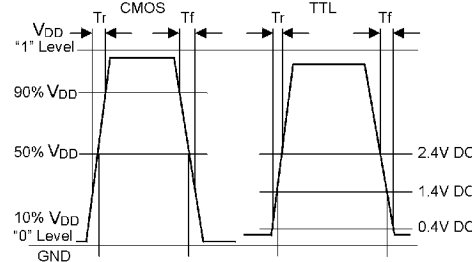

Test circuit:

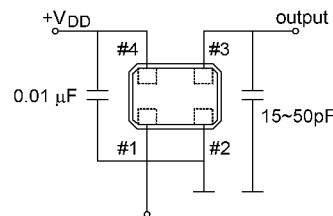

Suggested soldering pad:

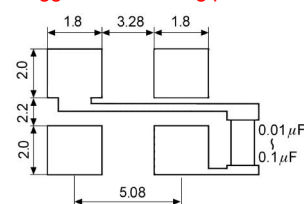

Reflow soldering condition:

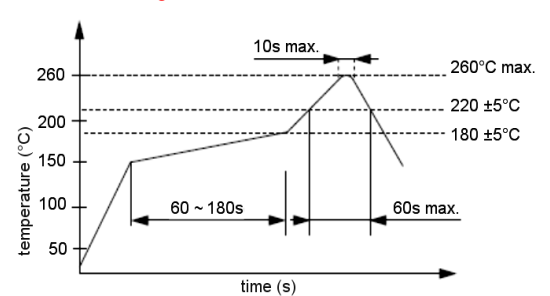

Tape specifications:

