



## Clock Oscillator

SMD-version

5V

part no.	12.94223
model	KXO-97
frequency	32.0 MHz
frequency stability at -20° ~ +70°C	±50 ppm
operating temperature	-20° ~ +70°C
storage temperature	-55° ~ +125°C
symmetry	50% ± 10% at 1.4V DC level or ½ V <sub>DD</sub> level
rise & fall time max.	TTL: 6 ns / CMOS: 10 ns
"O" level max.	+0.4V (TTL) +0.5V (CMOS)
"1" level min.	+2.4 (TTL) V <sub>DD</sub> -0.5V (CMOS)
input voltage V <sub>DD</sub>	+5V DC ±10%
Input current max.	35 mA
output load	10 TTL gates 50 pF
start up time max.	10 ms
tristate function	yes
disable delay time max.	50 µs
enable delay time max.	4 ms
phase jitter	(12 kHz – 20 MHz) with 1 ps
random jitter max.	7ps
peak to peak jitter max.	40ps
contents of reel	1000 pcs.

### Dimensions (mm):

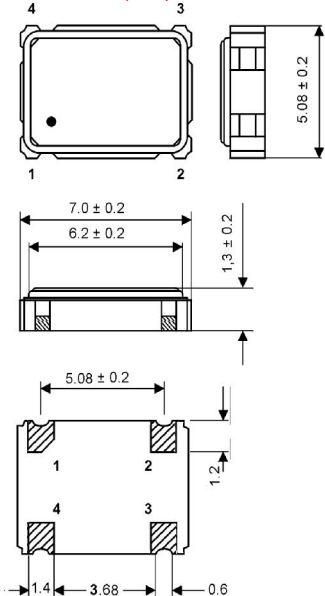

PIN	Connection
1	"L" (0V)   "H" or OPEN
2	GND
3	Z   OUTPUT
4	V <sub>DD</sub>

Z: high impedance

### Output waveform:

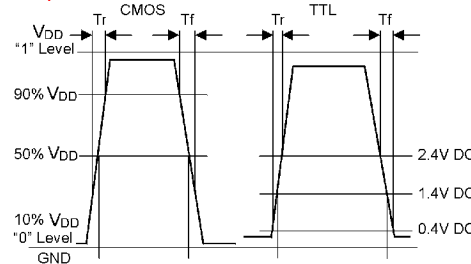

### Test circuit:

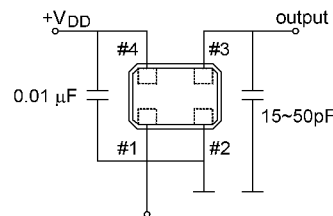

### Suggested soldering pad:

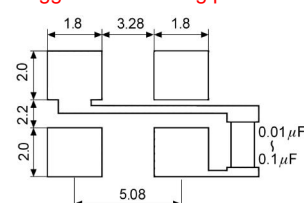

### Reflow soldering condition:

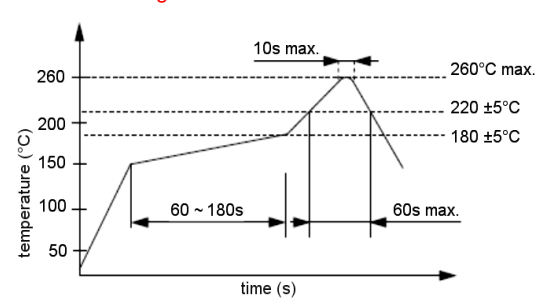

### Tape specifications:

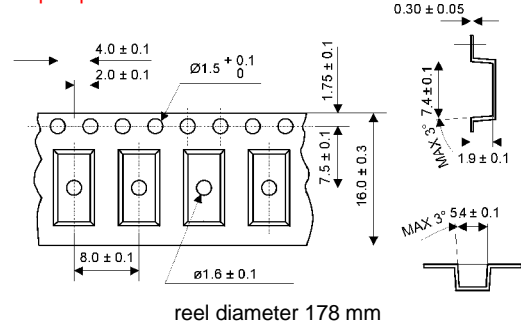

reel diameter 178 mm