

Quartz Crystal

SMD-version

part no.	12.88668
model	KX - 7
frequency	27.0 MHz
mode	fundamental
operating temperature	-20° ~ +70°C
frequency tolerance at +25°C	±30 ppm
temperature tolerance -20° ~ +70°C	±50 ppm
load capacitance C_L	12 pF
series resistance R_1 max.	50 Ohm
aging at 25°C (first year) max	±2 ppm
shunt capacitance C_O max.	3.0 pF
drive level max.	200 μ W
contents of reel	1000 pcs.

Dimensions (mm):

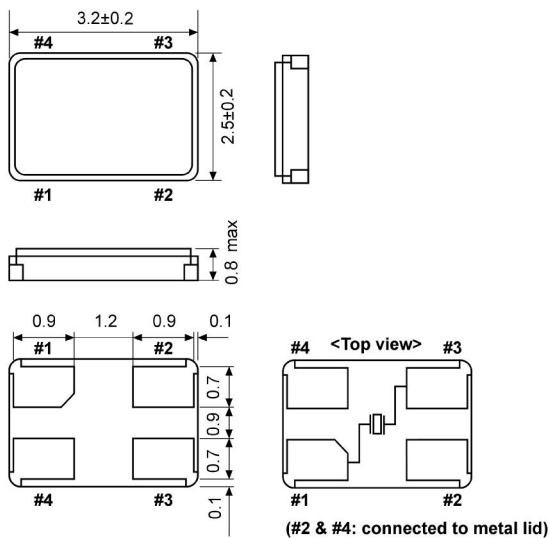

Reflow soldering condition:

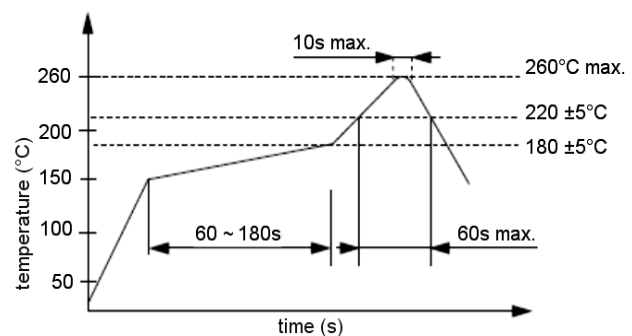

Suggested soldering pad:

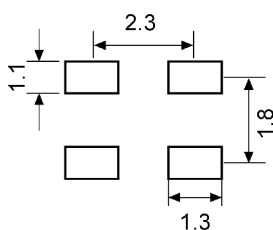

Tape specification:

