

## Quartz Crystal

SMD-version

part no.	12.88662
model	KX - 7
frequency	12.0 MHz
mode	fundamental
operating temperature	-20° ~ +70°C
frequency tolerance at +25°C	±30 ppm
temperature tolerance -20° ~ +70°C	±50 ppm
load capacitance $C_L$	12 pF
series resonance R1 max.	50 Ohm
aging at 25°C (first year) max	±2 ppm
shunt capacitance $C_O$ max.	3.5 pF
drive level max.	0.05 mW
contents of reel	1000 pcs.

### Dimensions (mm):

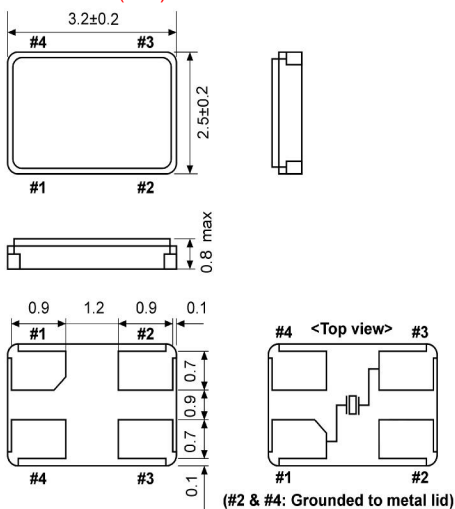

### Reflow soldering condition:

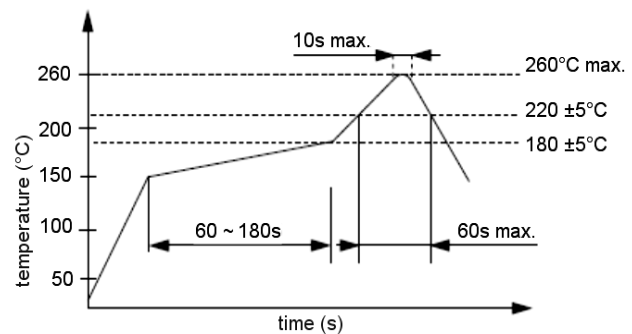

### Suggested soldering pad:

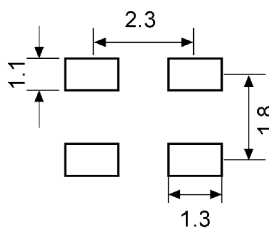

### Tape specification:

