



Quartz Crystal

SMD-version

model	KX – 5
frequency	40,0 MHz
mode	fundamental
operating temperature	-20° ~ +70°C
frequency tolerance at +25°C	± 10 ppm
temperature tolerance -20° ~ +70°C	± 20 ppm
load capacitance C_L	10 pF
series resonance R1 max.	80 Ohm
aging at +25°C (first year) max.	± 2 ppm
shunt capacitance C_O max.	3,5 pF
drive level	50 μ W typ., 100 μ W max.
contents of reel	1000 pcs.
part no.	12.85564

Dimensions (mm):

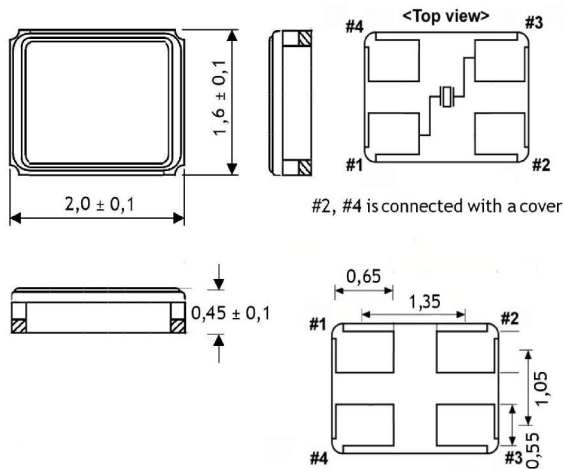

Reflow soldering condition:

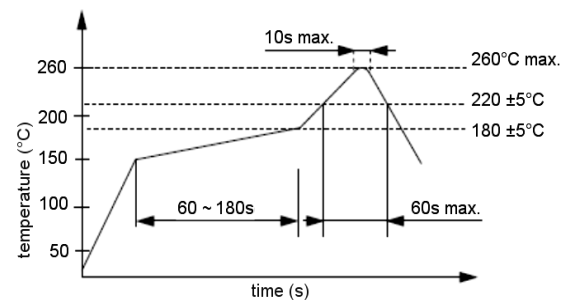

Suggested soldering pad:

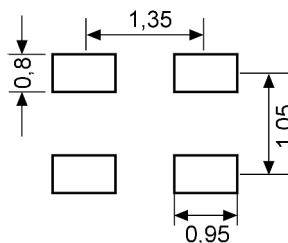

Tape specification:

